

## Features

### Mechanical time switches

- Daily time setting \*
- Weekly time setting \*\*

- **Type 12.01** - 1 Pole 16 A CO (SPDT)  
35.8 mm width
- **Type 12.11** - 1 Pole 16 A NO (SPST-NO)  
17.6 mm width
- **Type 12.31-0000** daily -  
1 Pole 16 A CO (SPDT)
- **Type 12.31-0007** weekly -  
1 Pole 16 A CO (SPDT)
- Minimum time interval setting:  
1h (12.31-0007)  
30 min (12.01)  
15 min (12.11 - 12.31-0000)

\* Same program every day

\*\* Different program possible for each of the 7 days of the week

For outline drawing see page 10

### Contact specification

Contact configuration	1 CO (SPDT)	1 NO (SPST-NO)	1 CO (SPDT)
Rated current/Maximum peak current A	16/—	16/30	16/—
Rated voltage/Maximum switching voltage V AC	250/—	250/—	250/—
Rated load AC1 VA	4,000	4,000	4,000
Rated load AC15 (230 V AC) VA	750	420	420
Nominal lamp rating: incandescent (230 V) W	2,000 (NO contact)	2,000	2,000
compensated fluorescent (230 V) W	750 (NO contact)	750	750
uncompensated fluorescent (230 V) W	1,000 (NO contact)	1,000	1,000
halogen (230 V) W	2,000 (NO contact)	2,000	2,000
Minimum switching load mW (V/mA)	1,000 (10/10)	1,000 (10/10)	1,000 (10/10)
Standard contact material	AgCdO	AgCdO	AgCdO

### Supply specification

Nominal voltage (U <sub>N</sub> )	V AC (50/60 Hz)	230	230	120 - 230
	V DC	—	—	—
Rated power AC/DC	VA (50 Hz)/W	2/—	2/—	2/—
Operating range	AC (50 Hz)	(0.85...1.1)U <sub>N</sub>	(0.85...1.1)U <sub>N</sub>	(0.85...1.1)U <sub>N</sub>
	DC	—	—	—

### Technical data

Electrical life at rated load in AC1	cycles	50 · 10 <sup>3</sup>	50 · 10 <sup>3</sup>	50 · 10 <sup>3</sup>
Type of time switch		daily	daily	daily      weekly
Switching intervals /day		48	96	96      24 (168/week)
Minimum switching interval	min	30	15	15      60
Accuracy	s/day	1.5	1.5	1.5
Ambient temperature range	°C	-5...+50	-5...+50	-10...+50
Protection category		IP 20	IP 20	IP 20

### Approvals (according to type)



**12.01**



- Mechanical daily time switch
- 1 CO (SPDT)
- 35 mm rail (EN 60715) mount

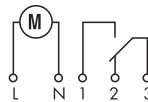

**12.11**



- Mechanical daily time switch
- 1 NO (SPST-NO)
- 35 mm rail (EN 60715) mount

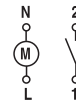

**12.31**



- Mechanical daily or weekly
- 1 CO (SPDT)
- Front panel mounting

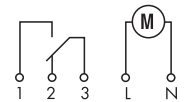

## Features

### 12.51 - Digital (analogue-style) time switch, daily/weekly programming

- 30 minutes interval setting
- Easily configurable for daily or weekly programming

### 12.81 - Digital astro-switch

- Astro program: calculation of sunrise and sunset times through date, time and location coordinates
- Location coordinates easily settable for most European countries through post codes
- Offset function: allows programming of switching times offset from the astronomical time (up to  $\pm 90'$ , with  $10'$  steps)

- Summer/winter European time
- 1 CO 16 A output contact
- LCD status indication, set-up and programming
- Back-light display
- Internal battery for set-up and programming without supply, easily replaceable from the front
- Protective separation between supply and contacts
- 35 mm rail (EN 60715) mount
- Cadmium free contact material

**NEW** 12.51



- Digital time switch
- 1 CO (SPDT)
- 35 mm rail (EN 60715) mount

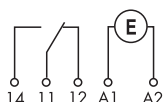

**NEW** 12.81



- Astro-time switch
- 1 CO (SPDT)
- 35 mm rail (EN 60715) mount

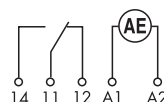

For outline drawing see page 10

Contact specification			
Contact configuration		1 CO (SPDT)	1 CO (SPDT)
Rated current/Maximum peak current	A	16 / 30 (120 A – 5 ms)	16 / 30 (120 A – 5 ms)
Rated voltage/Maximum switching voltage V AC		250/400	250/400
Rated load AC1	VA	4,000	4,000
Rated load AC1.5 (230 V AC)	VA	750	750
Nominal lamp rating: (230 V) W	incandescent	2,000	2,000
	compensated fluorescent	750	750
	energy saving (CFL, LED)	200	200
	halogen	2,000	2,000
Minimum switching load	mW (V/mA)	1,000 (10/10)	1,000 (10/10)
Standard contact material		AgSnO <sub>2</sub>	AgSnO <sub>2</sub>
Supply specification			
Nominal voltage (U <sub>N</sub> )	V AC (50/60 Hz)	230	230
	V DC	—	—
Rated power	VA (50 Hz)/W	6.6/2.9	6.6/2.9
Operating range	AC (50 Hz)	(0.8...1.1)U <sub>N</sub>	(0.8...1.1)U <sub>N</sub>
	DC	—	—
Technical data			
Electrical life at rated load in AC1	cycles	100 · 10 <sup>3</sup>	100 · 10 <sup>3</sup>
Switching intervals		48	—
Minimum switching interval		30	—
Accuracy	s/day	1	1
Ambient temperature range		-20...+50	-20...+50
Protection category		IP 20	IP 20
Approvals (according to type)		CE	PG

## Features

### Electronic digital time switches

#### - Weekly time setting

- **Type 12.21** - 1 Pole 16 A CO (SPDT)  
35.8 mm width
- **Type 12.22** - 2 Pole 16 A CO (DPDT)  
35.8 mm width
- **Type 12.71** - 1 Pole 16 A CO (SPDT)  
17.6 mm width
- Available for 230 V AC or 12, 24 V AC/DC supply
- Minimum time interval setting - 1 minute
- Internal battery for set-up without supply
- Impulse output function:  
- 1s... 59: 59(mm:ss)
- Automatic adjustment for daylight saving
- 35 mm rail (EN 60715) mount

### 12.21



- Digital weekly time switch
- 1 CO (SPDT)
- 35 mm rail (EN 60715) mount

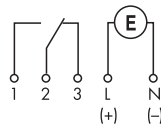

### 12.22



- Digital weekly time switch
- 2 CO (DPDT)
- 35 mm rail (EN 60715) mount

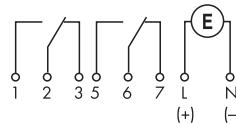

### 12.71



- Digital weekly time switch
- 1 CO (SPDT)
- 35 mm rail (EN 60715) mount

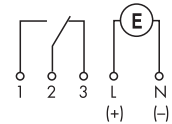

For outline drawing see page 10, 11

### Contact specification

Contact configuration	1 CO (SPDT)	2 CO (DPDT)	1 CO (SPDT)
Rated current/Maximum peak current A	16/30	16/30	16/30
Rated voltage/Maximum switching voltage V AC	250/—	250/—	250/—
Rated load AC1 VA	4,000	4,000	4,000
Rated load AC15 (230 V AC) VA	750	750	420
Nominal lamp rating: incandescent (230 V) W	2,000 (NO contact)	2,000 (NO contact)	2,000 (NO contact)
compensated fluorescent (230 V) W	420 (NO contact)	420 (NO contact)	750 (NO contact)
uncompensated fluorescent (230 V) W	1,000 (NO contact)	1,000 (NO contact)	1,000 (NO contact)
halogen (230 V) W	2,000 (NO contact)	2,000 (NO contact)	2,000 (NO contact)
Minimum switching load mW (V/mA)	1,000 (10/10)	1,000 (10/10)	1,000 (10/10)
Standard contact material	AgCdO	AgCdO	AgNi

### Supply specification

Nominal voltage (U <sub>N</sub> )	V AC (50/60 Hz)	—	120 - 230	—	120 - 230	—	230
	V AC/DC	12 - 24	—	24	—	24	—
Rated power AC/DC VA (50 Hz)/W	1.4/1.4	2/—	1.4/1.4	2/—	1.4/1.4	2/—	—
Operating range	AC (50 Hz)	(0.9...1.1)U <sub>N</sub>	(0.85...1.1)U <sub>N</sub>	(0.9...1.1)U <sub>N</sub>	(0.85...1.1)U <sub>N</sub>	(0.9...1.1)U <sub>N</sub>	(0.85...1.1)U <sub>N</sub>
	DC	(0.9...1.1)U <sub>N</sub>	—	(0.9...1.1)U <sub>N</sub>	—	(0.9...1.1)U <sub>N</sub>	—

### Technical data

Electrical life at rated load in AC1 cycles	50 · 10 <sup>3</sup>	50 · 10 <sup>3</sup>	50 · 10 <sup>3</sup>
Type of time switch	weekly	weekly	weekly
Memory locations for switching times *	30	30	30
Minimum interval setting min	1	1	1
Accuracy s/day	0.5	0.5	0.5
Ambient temperature range °C	-30...+55	-30...+55	-30...+55
Protection category	IP 20	IP 20	IP 20

### Approvals (according to type)



\* Switching times in memory may be used more than once i.e. when selected for different days.

## Features

### Electronic digital time switches

#### - weekly time setting

- **Type 12.91...0000 "ZENITH"**  
1 pole 16 A CO (SPDT)  
35.8 mm width
- **Type 12.91...0090 "ZENITH"**  
1 pole 16 A CO (SPDT)  
35.8 mm width  
version for programming via PC by a special Key Memory (included)
- **Type 12.92 "ZENITH"**  
2 Pole 16 A CO (DPDT)  
35.8 mm width
- Astro program:  
calculation of sunrise and sunset times through date, time and location coordinates (longitude and latitude)
- Offset function: allows programming of switching times offset (+ or -) from the astrological time
- Minimum time interval setting - 1 minute
- Internal battery for set-up without supply
- Automatic adjustment for daylight saving
- 35 mm rail (EN 60715) mount

12.91...0000



- Digital weekly time switch
- 1 CO (SPDT)
- 35 mm rail (EN 60715) mount

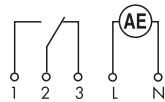

**NEW** 12.91...0090



- Digital weekly time switch
- 1 CO (SPDT)
- Version for programming via PC by a special key memory
- 35 mm rail (EN 60715) mount

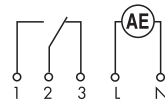

12.92



- Digital weekly time switch
- 2 CO (DPDT)
- 35 mm rail (EN 60715) mount

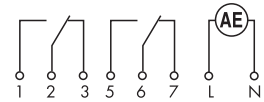

For outline drawing see page 11

Contact specification				
Contact configuration		1 CO (DPDT)	1 CO (DPDT)	2 CO (DPDT)
Rated current/Maximum peak current	A	16/30	16/30	16/30
Rated voltage/Maximum switching voltage	V AC	250/—	250/—	250/—
Rated load AC1	VA	4,000	4,000	4,000
Rated load AC15 (230 V AC)	VA	750	750	750
Nominal lamp rating: incandescent (230 V)	W	2,000 (NO contact)	2,000 (NO contact)	2,000 (NO contact)
compensated fluorescent (230 V)	W	420 (NO contact)	420 (NO contact)	420 (NO contact)
uncompensated fluorescent (230 V)	W	1,000 (NO contact)	1,000 (NO contact)	1,000 (NO contact)
halogen (230 V)	W	2,000 (NO contact)	2,000 (NO contact)	2,000 (NO contact)
Minimum switching load	mW (V/mA)	1,000 (10/10)	1,000 (10/10)	1,000 (10/10)
Standard contact material		AgSnO <sub>2</sub>	AgSnO <sub>2</sub>	AgSnO <sub>2</sub>
Supply specification				
Nominal voltage (U <sub>N</sub> )	V AC (50/60 Hz)	230	230	230
Rated power AC/DC	VA (50 Hz)/W	2/—	2/—	2/—
Operating range	AC (50 Hz)	(0.85...1.1)U <sub>N</sub>	(0.85...1.1)U <sub>N</sub>	(0.85...1.1)U <sub>N</sub>
Technical data				
Electrical life at rated load in AC1	cycles	50 · 10 <sup>3</sup>	50 · 10 <sup>3</sup>	50 · 10 <sup>3</sup>
Type of time switch		weekly	weekly	weekly
Memory locations for switching times *		60	60	60
Minimum interval setting	min	1	1	1
Accuracy	s/day	0.5	0.5	0.5
Ambient temperature range	°C	-30...+55	-30...+55	-30...+55
Protection category		IP 20	IP 20	IP 20
Approvals (according to type)				

## Ordering information

Example: 12 series digital/analogue time switch, 1 CO 16 A contact, 230 V AC supply

**1 2 . 5 1 . 8 . 2 3 0 . 0 0 0 0**

**Series**

**Type**

- 0 = Daily, 35.8 mm wide
- 1 = Daily, 17.5 mm wide
- 3 = Daily or Weekly, 72x72 mm
- 5 = Digital/analogue time switch, 35 mm wide
- 2 = Weekly, 35.8 mm wide
- 7 = Weekly, 17.5 mm wide
- 8 = Astro-switch, 35 mm wide
- 9 = Weekly "Astro", 35.8 mm wide

**No. of poles**

- 1 = 1 CO (SPDT), 16 A
- 2 = 2 CO (DPDT), 16 A (type 12.22 and 12.92)

**Option**

- 0 = With power back-up
- 1 = Without power back-up (type 12.11)

**Supply voltage**

- 012 = 12 V AC/DC
- 024 = 24 V AC/DC
- 120 = 120 V AC
- 230 = 230 V AC

**Supply version**

- 0 = AC (50/60 Hz)/DC (types 12.21.0.012, 12.21.0.024, 12.22.0.024, 12.71.0.024)
- 8 = AC (50/60 Hz)

**Option**

- 0 = Standard
- 0 = Daily only for 12.31
- 7 = Weekly only for 12.31

**Special version**

- 0 = Standard
- 9 = Programming via PC (type 12.91.8.230.0090)

## Technical data

<b>Insulation</b>	<b>12.01, 12.11, 12.31</b>	<b>12.21, 12.22, 12.71, 12.91, 12.92</b>		
Dielectric strength between open contacts V AC	1,000	1,000		
<b>Other data</b>	<b>12.01, 12.11, 12.31</b>	<b>12.21, 12.22, 12.71, 12.91, 12.92</b>		
Power back-up	100 h (following 80 h continuous energisation)	6 years		
Power lost to the environment				
without contact current W	1.5	2		
with rated current W	2.5	3 (for 1 pole)	4 (for 2 pole)	
 Screw torque Nm	1.2	1.2		
Max. wire size	solid cable	stranded cable	solid cable	stranded cable
	mm <sup>2</sup>	1x6 / 2x4	1x6 / 2x2.5	1x6 / 2x4
	AWG	1x10 / 2x12	1x10 / 2x14	1x10 / 2x12

## Technical data type 12.51 and 12.81

<b>Insulation</b>		<b>Dielectric strength</b>	<b>Impulse (1.2/50 µs)</b>
	between supply and contacts	4,000 V AC	6 kV
	between open contacts	1,000 V AC	1.5 kV
<b>EMC specifications</b>			
<b>Type of test</b>		<b>Reference standard</b>	
Electrostatic discharge	contact discharge	EN 61000-4-2	4 kV
	air discharge	EN 61000-4-2	8 kV
Radiated electromagnetic field (80 ... 1,000 MHz)		EN 61000-4-3	10 V/m
Fast transients (burst 5/50 ns, 5 and 100 kHz)		EN 61000-4-4	4 kV
Voltage pulses on supply terminals (surge 1.2/50 µs)	common mode	EN 61000-4-5	4 kV
	differential mode	EN 61000-4-5	4 kV
Radiofrequency common mode voltage (0.15...80 MHz)		EN 61000-4-6	10 V
Voltage dips	70 % U <sub>N</sub> , 40 % U <sub>N</sub>	EN 61000-4-11	10 cycles
Short interruptions		EN 61000-4-11	10 cycles
Radio frequency conducted emissions	0.15...30 MHz	EN 55014	class B
Radiated emissions	30...1,000 MHz	EN 55014	class B
<b>Terminals</b>			
 Screw torque		0.8 Nm	
Max. wire size	solid cable	1 x 6 / 2 x 4 mm <sup>2</sup>	1 x 10 / 2 x 12 AWG
	stranded cable	1 x 4 / 2 x 2.5 mm <sup>2</sup>	1 x 12 / 2 x 14 AWG
Wire strip length		9 mm	
<b>Other data</b>			
Power back-up (Battery life)		6 years	
Battery type		CR 2032, 3 V, 230 mAh	
Power lost to the environment	in stand-by	1.4 W	
	without contact current	2.9 W	
	with rated current	3.5 W	

Wiring diagrams

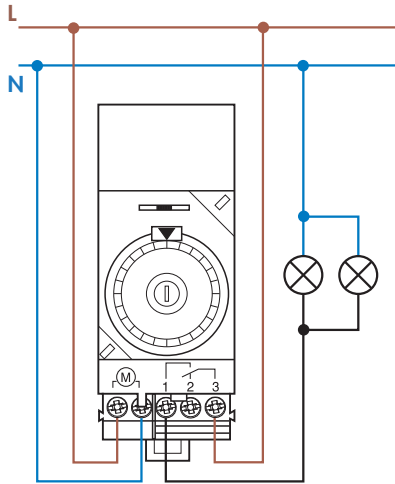

**Type 12.01**  
 Selector switch:  
 ⊖ = Permanently OFF  
 AUTO = Automatic  
 I = Permanently ON

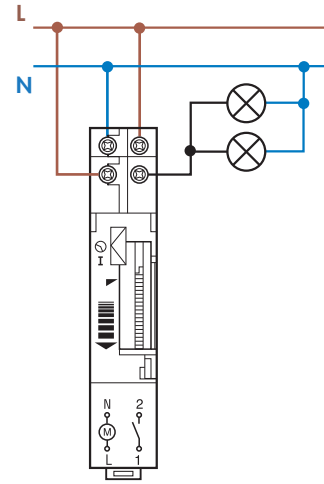

**Type 12.11**  
 Selector switch:  
 ⊖ = Automatic  
 I = Permanently ON

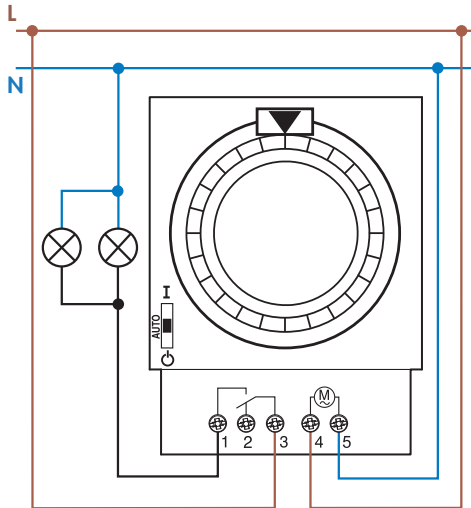

**Type 12.31**

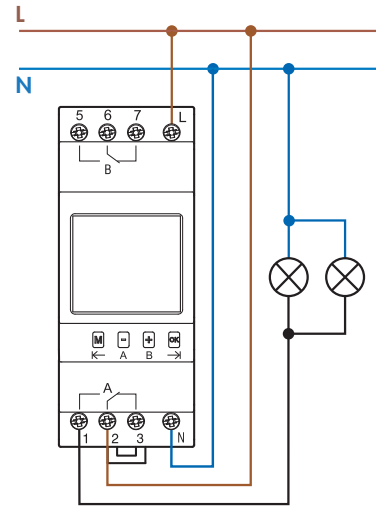

**Type 12.21**  
**12.22**  
**12.91**  
**12.92**

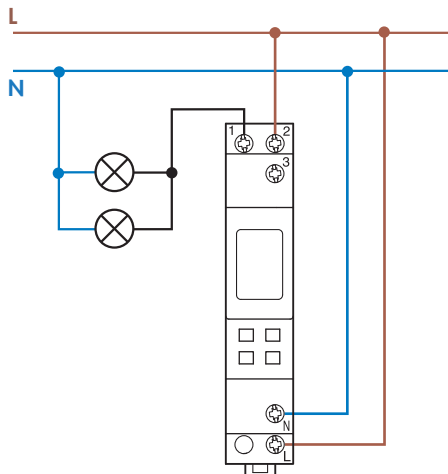

**Type 12.71**

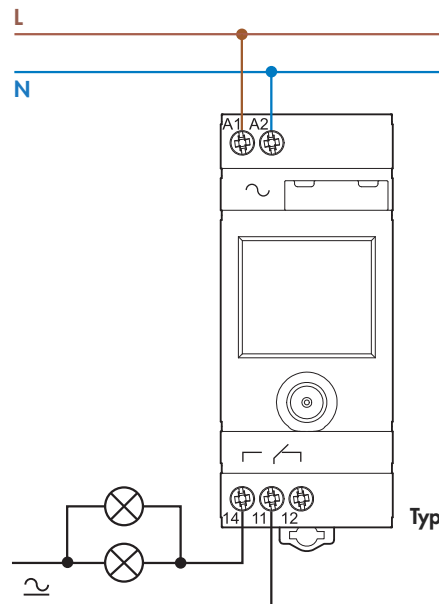

**Type 12.51**  
**12.81**

## Accessories for type 12.71 and 12.91



012.90

**PC programming kit** for type 12.71, 12.91.8.230.0090 | 012.90

This special PC programming kit, permits fast and easy programming of the Time Switch with a PC or Laptop. The program transfer can be done by the special Key Memory (supplied with the 12.91.8.230.0090) or directly by the Time switch 12.71.

Contents: Programming adaptor, USB cable (1.8 meter length), Software.

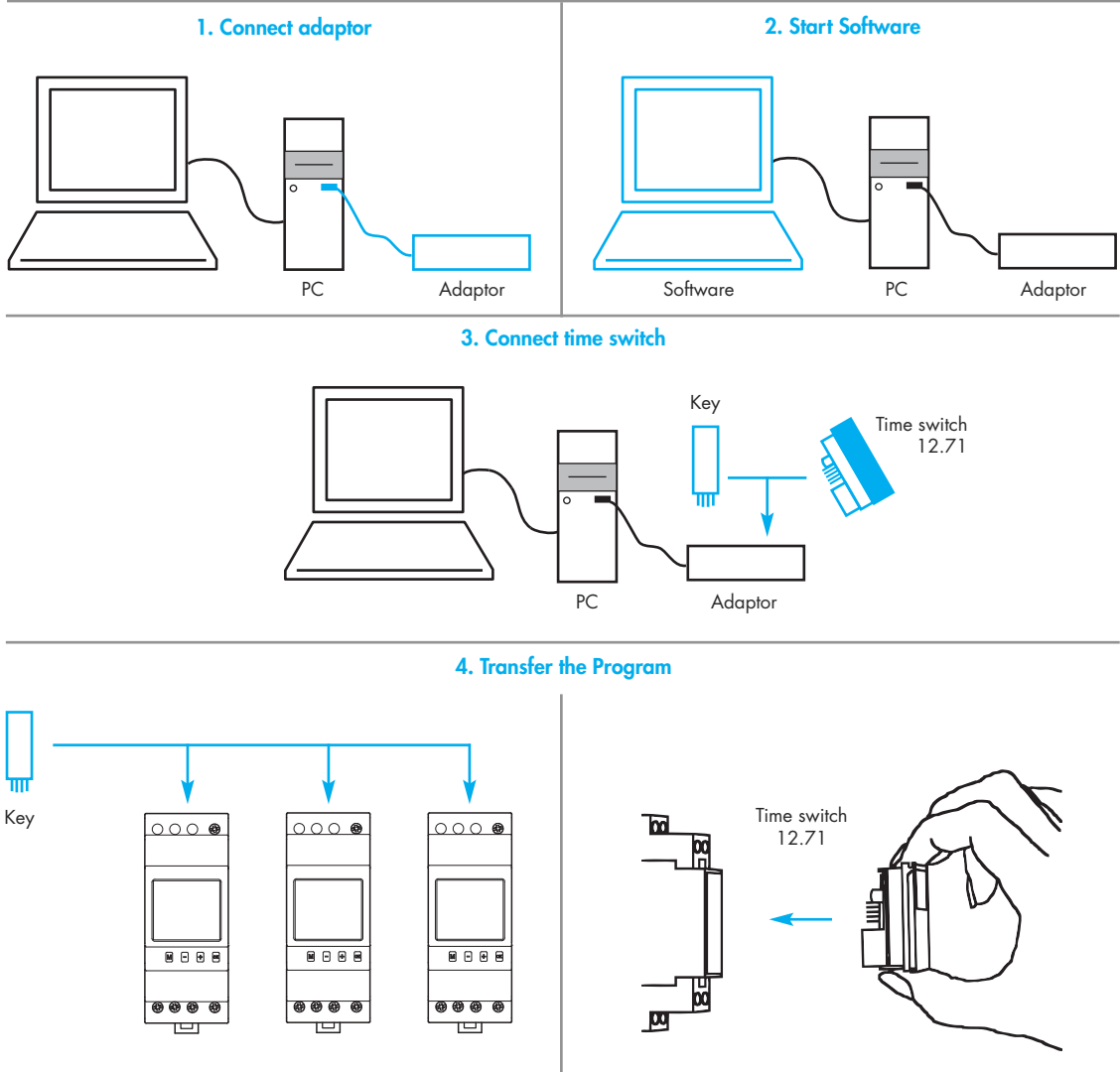

## PC Programming software

Easy and intuitive software to create programs for the Time Switch, in a few fast steps. For Windows 2000/XP/Vista.

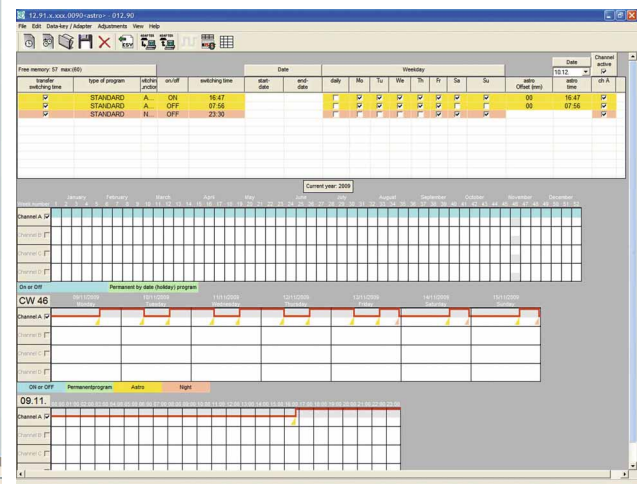
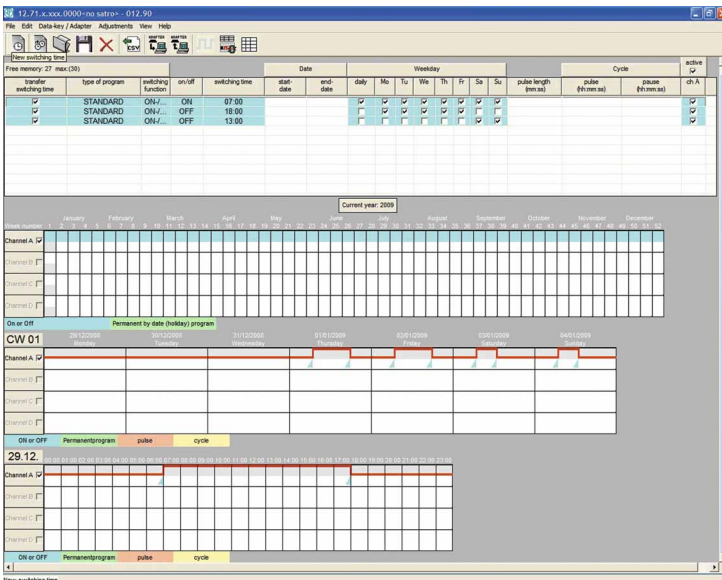



**Battery replacement type 12.51 and 12.81**



**Accessories type 12.51 and 12.81**



011.01

**Adaptor for panel mounting, 35 mm wide**

011.01

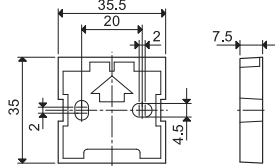

**Outline drawings**

12.01  
Screw terminal

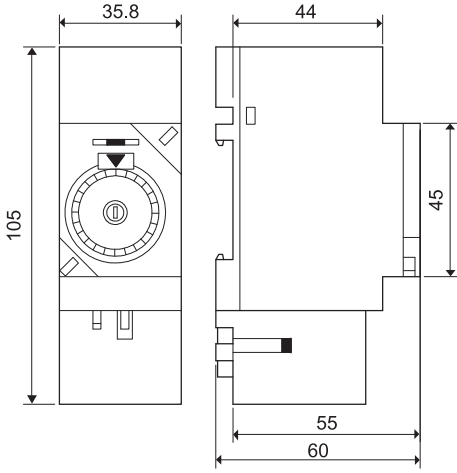

12.11  
Screw terminal

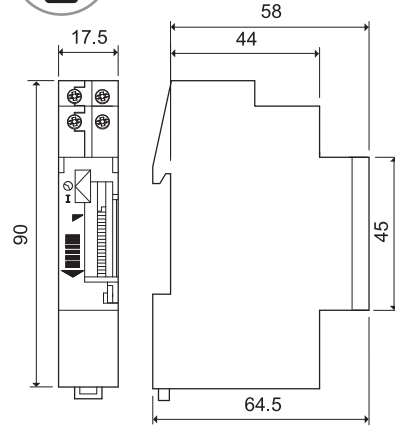

12.21  
Screw terminal

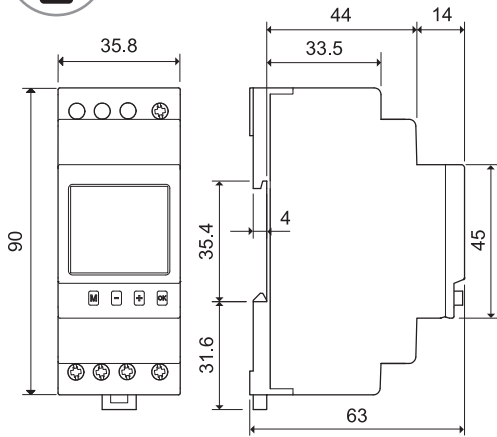

12.22  
Screw terminal

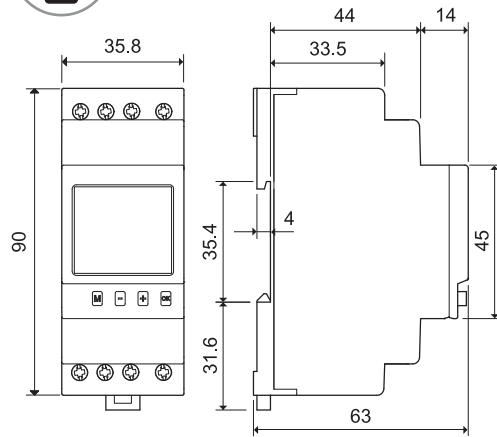

12.31  
Screw terminal

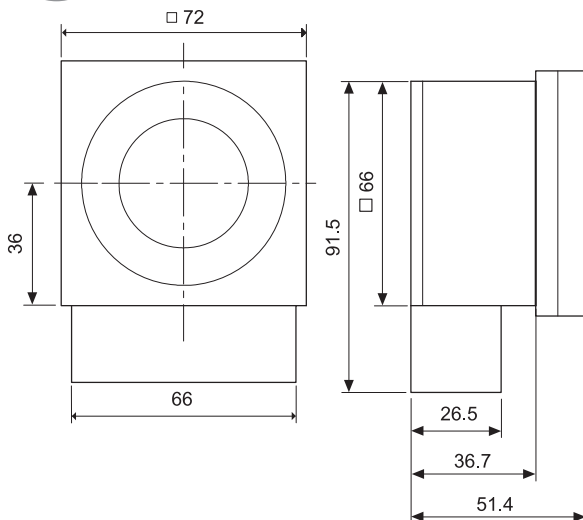

12.51/12.81  
Screw terminal

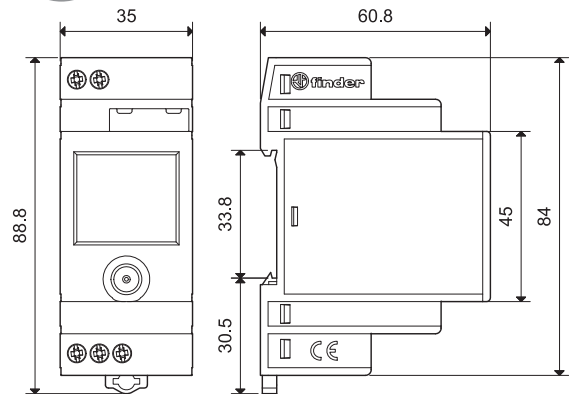

Outline drawings

12.71  
Screw terminal

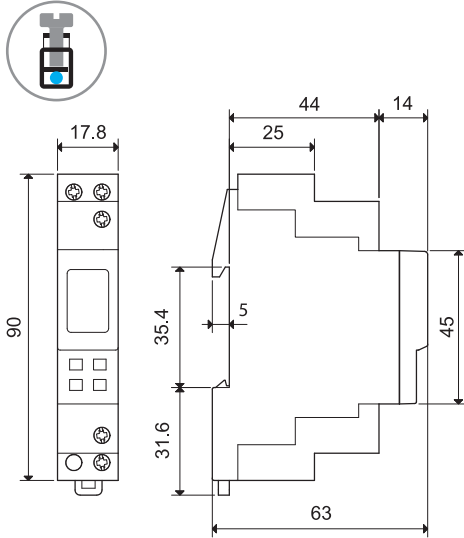

12.91...0000  
Screw terminal

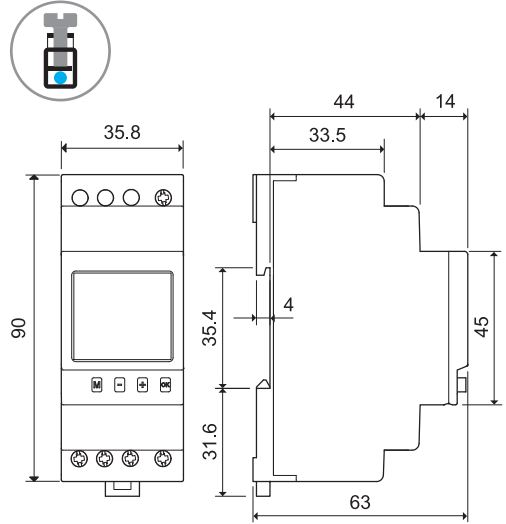

12.91...0090  
Screw terminal

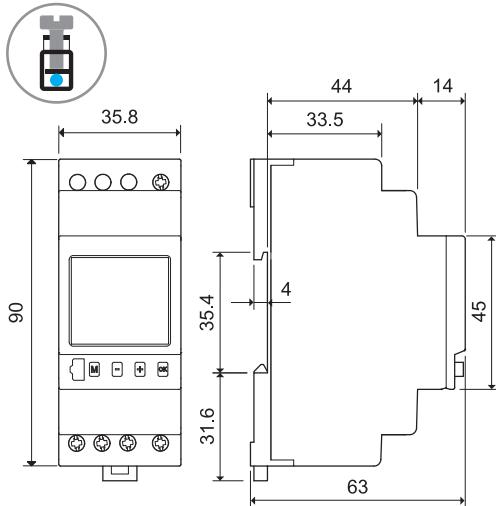

12.92  
Screw terminal

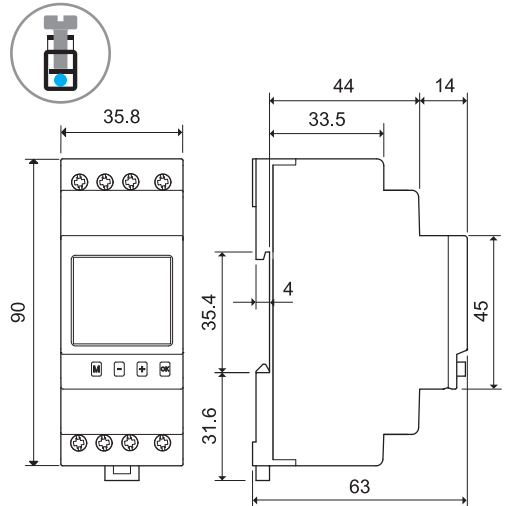

## Functions type 12.51

All the functions and the values can be set through the front joystick and are displayed on the front LCD.

### Display mode

During normal operation, with AC supply connected, the following is displayed:

- the current time (hours and minutes)
- the status (ON/OFF and symbol of contact open/closed) of the 11-14 output contact
- the program for the current day (each solid segment represents an half-hour interval set to ON)

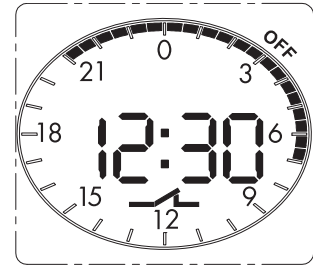

From **Display mode** it is possible to enter in **Program mode** or **Setup mode** respectively with a short or long (> 2") press to the joystick centre (⊙).

### Hand mode

From **Display mode** it is also possible to enter in **Hand mode**, where (independently from the program) the 11-14 output contact is forced to the ON or OFF position with a long (> 2") press to the joystick

⬆ or ⬇ directions, respectively. The "hand" symbol is then displayed.

A long press in the opposite direction will exit the hand mode.

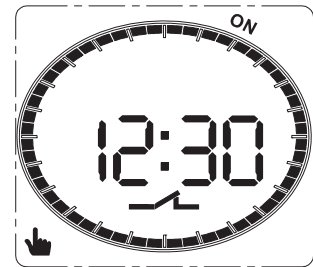

### Setup mode

In this mode it is possible to set (in the following order):

- daily/weekly function
- current year
- current day
- current month
- current hour
- current minute
- enable/disable european summer time.

With a short press of the joystick ⬆ or ⬇, it is possible to pass from one setup step to another (confirming the set values); in any step it is possible to modify the set values with a short press to the joystick ⬆ or ⬇. A sustained (> 1") press results in the fast increasing (or decreasing) of values.

A short press to the joystick centre (⊙) will restore the Display mode.

Note: the product is supplied factory set to Central Europe time with european summer time enabled.

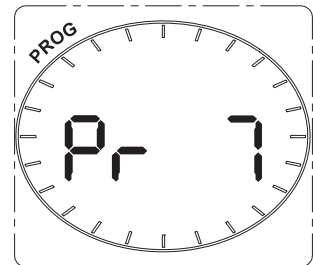

## Functions type 12.51

### Program mode (daily)

In this mode it is possible to set the "pattern" of time segments, which define the ON time of the 11-14 output contact. This "pattern" will be the same for all days of the week (daily).

Entering Programming mode (from Display mode) with a short press to takes the digital time to 00:00 (and any previously programmed segment pattern is displayed). Stepping backwards or forwards in time displays the appropriate segment time and the appropriate open or closed contact status for that time segment.

At any step it is possible to change the segment status with a short press to the joystick (for ON) or (for OFF) as appropriate, and this also automatically advances the time to the next segment, and always in a clockwise direction. If the joystick is pressed several times in, say, the direction then each successive segment will assume the ON status. If it is then pressed several times in the direction then each successive segment will assume the OFF status. This allows the rapid setting of many consecutive segments with the same status.

A short press to the joystick centre will restore the display to the Display mode.

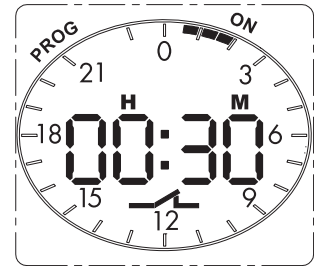
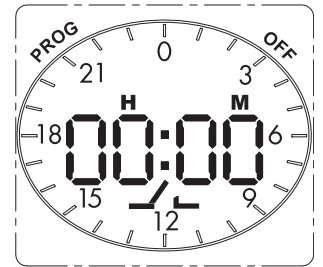

### Program mode (weekly)

In this mode it is possible to set a different "pattern" of time segments for each day of the week (weekly).

Entering Programming mode (from Display mode) with a short press to takes the display to the programming mode, for the current day. With a subsequent short press to or it is possible to pass from one day to another (Monday is day 1).

With the desired day selected it is possible to enter the programming mode for that day by pressing . Program the segments for that day by following the same procedure as described above for daily mode. When all 48 segments have been set, accept with a short press to . Then progress to the next day by pressing the joystick in the or direction. Repeat programming for the next day, and then repeat for other remaining days.

At any time return to the Display mode with a short press to the joystick centre .

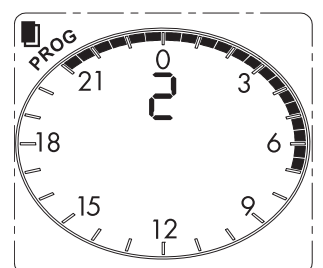
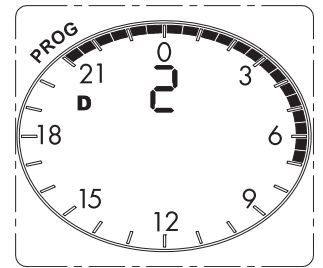

### COPY FUNCTION

View the particular day to be copied (using or as described above) and copy with a short press to (the "copy icon" will then appear).

Then select another day, using or , and paste the copied program with a short press to .

A short press to the joystick centre , or , will exit the copy function.

### Power-save mode

If the 230 V AC supply is not connected, the time switch enters power-save mode: only the clock is maintained active whilst the display turns off so as to guarantee a long life for the built-in back-up battery.

With a press to the joystick it is possible to "awake" the device and enter Display mode (with the "plug" symbol displayed). A further press to will enter the program or set-up mode as explained in the Display mode section above.

After about 1 minute of inactivity the power-save mode will start again. During program or set-up the current absorption is higher than in power-save mode, thus influencing the battery life.

In this mode the display back-light is not active. It is activated following a press to the joystick only with the 230 V AC supply connected, but after about 1 minute of inactivity the display back-light will turn off, and to activate it again it is necessary to press the joystick again.

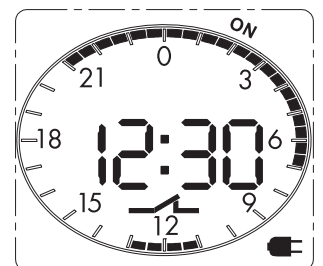

## Functions type 12.81

All the functions and the values can be set through the front joystick and are displayed on the front LCD.

### Display mode

During normal operation, with AC supply connected, the following is displayed:

- the current time (hours and minutes)
- the status (ON/OFF and symbol of contact open/closed) of the 11-14 output contact

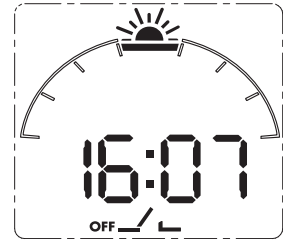

From **Display mode** it is possible to enter in **Program mode** or **Setup mode** respectively with a short or long (> 2") press to the joystick centre (⊙).

### Hand mode

From **Display mode** it is also possible to enter in **Hand mode**, where (independently from the program) the 11-14 output contact is forced to the ON or OFF position with a long (> 2") press to the joystick

⬆ or ⬇ directions, respectively. The "hand" symbol is then displayed.

A long press in the opposite direction will exit the hand mode.

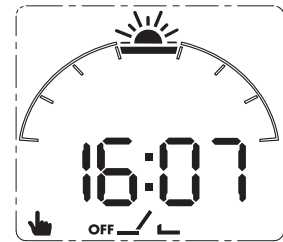

### Setup mode

In this mode it is possible to set (in the following order):

- country (using Internet websites extension, e.g. IT, DE, FR..)
- post-code (CP, setting only the first 2 digits, 00 to 99),
- current year
- current day
- current month
- current hour
- current minute
- enable/disable european summer time.

With a short press of the joystick ⬆ or ⬇, it is possible to pass from one setup step to another (confirming the set values); in any step it is possible to modify the set values with a short press to the joystick ⬆ or ⬇. A sustained (> 1") press results in the fast increasing (or decreasing) of values.

A short press to the joystick centre (⊙) will restore the Display mode.

When the post-code is set to -- (between 99 and 00), the manual setting of geographic coordinates is possible: moving right side the joystick, it is visualized the latitude (settable between 30 and 64°North), then the longitude (settable between 16°West and 50°East), finally the Time Zone (Gmt, settable to 00-Greenwich time, 01-Central Europe time, 02-Eastern Europe time or 03-European Russia time); then year and the other setting follows.

Note: the product is supplied with the following factory settings:

- Central Europe time,
- european summer time enabled,
- country Italy,
- post-code 00 (the capital city Rome).

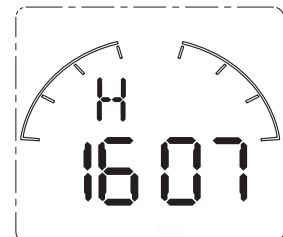
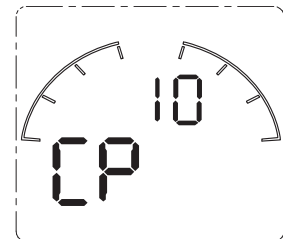
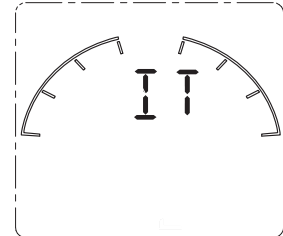
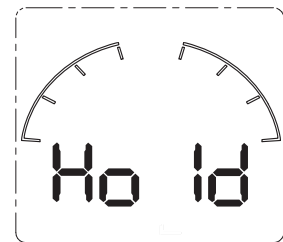

## Functions type 12.81

### Program mode (anticipate/delay setting)

In this mode it is possible to set independently:

- the anticipate (or the delay) of the light turn-off time in the morning with respect to the "astronomic" sunrise time, depending on the area (post-code or geographical coordinates) set and on the actual day;
- the anticipate (or the delay) of the light turn-on time in the evening with respect to the "astronomic" sunset time.

After entering in Program mode, it is displayed the "astronomic" sunrise time (indicated by the rising sun following the moon, the OFF and the open contact symbols); with a short pressure of the joystick respectively or , it is possible to delay/anticipate, with 10 minutes step, the light turn-off time. This setting will be obviously valid all days, that is the light will always turn-off, for example, 30 minutes after the "astronomic" sunrise.

A short pressure of the joystick or side will show the "astronomic" sunset time (indicated by the falling sun preceding the moon, the ON and the closed contact symbols); with a short pressure of the joystick respectively or , it is possible to delay/anticipate, with 10 minutes step, the light turn-on time. This setting will be obviously valid all days, that is the light will always turn-on, for example, 30 minutes before the "astronomic" sunset.

A short pressure of the joystick or side will continue to alternate the display/setting of turn-off time (sunrise) with the turn-on time (sunset).

A short press to the joystick centre will restore the display to the Display mode.

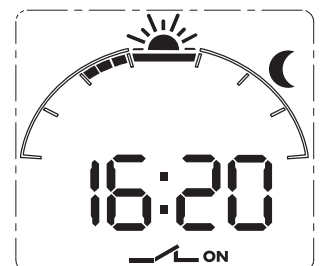
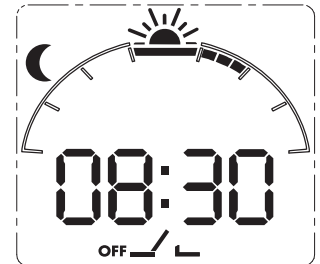
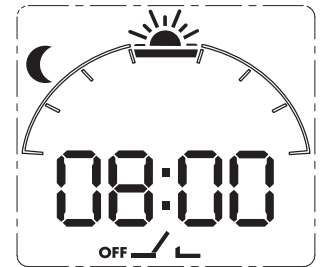

### Power-save mode

If the 230 V AC supply is not connected, the time switch enters power-save mode: only the clock is maintained active whilst the display turns off so as to guarantee a long life for the built-in back-up battery. With a press to the joystick it is possible to "awake" the device and enter Display mode (with the "plug" symbol displayed). A further press to will enter the program or set-up mode as explained in the Display mode section above.

After about 1 minute of inactivity the power-save mode will start again. During program or set-up the current absorption is higher than in power-save mode, thus influencing the battery life.

In this mode the display back-light is not active. It is activated following a press to the joystick only with the 230 V AC supply connected, but after about 1 minute of inactivity the display back-light will turn off, and to activate it again it is necessary to press the joystick again.

